

Etude[®] Plus Low



Safety and comfort



Invacare **Etude Plus Low**

With its attractive aesthetics, flexible design and easy handling, the **Etude Plus Low** is ideal for Community and residential care, especially for those 'at risk' of falling from bed. The **Etude Plus Low** is available with the option of innovative '**Shear Management Technology**', which helps to reduce shear and friction forces, a key factor in the prevention of pressure ulcers. The backrest auto-regression mechanism swings up and back as the bed profiles, reducing the propensity for the client to slide down the bed.



Modern and Flexible

The streamlined, discreet design perfectly complements any interior. The bed can be configured with steel or wood side rails with the option of ordering the bed with an extra wood plate to cover the bed end actuator if required. Small details make a big difference to personal comfort, as the **Etude Plus Low** can be customised with auto-regression for increased comfort and reduction in shear and friction.* A lockable hand control is also available for increased safety. The standard, built-in double-brackets are designed to suit any client's transfer needs by offering different positions (entrance height of 270 mm or a lower alternative of 200 mm).

Easy handling & storage

Portability and storage are key benefits of the **Etude Plus Low**. Its simplistic design allows easy assembly and dismantling without tools, and the process can be safely and comfortably managed by one person (each section weighs less than 25 kg). The bed ends can be easily attached to the transport unit making the **Etude Plus Low** lightweight and manoeuvrable for handling and storage.

Highest possible safety levels

The **Etude Plus Low** fully conforms to IEC 60601-2-52, the standard for beds. This equates to the highest degree of safety for both client and carer. The **Etude Plus Low** is compatible with three different ranges of side rail which all meet these stringent safety standards.

Features and options



Built-In low version with double brackets

Easy and quick attachment of mattress support to bed ends in either 270 - 670 mm or 200 - 600 mm adjustment height.



Easy Maintenance

Motors can be dismantled without tools. The cabling between the control unit and the motor is easy to access and replace.



Shear Management Technology

Improved comfort when seated. Reduced shear and friction.



Hand Control

Slim, ergonomic hand control. Choose with or without lockable functions (lockable handset available as an option).

Features and options



Etude Plus Low - Safety and security assured

The extra low height levels are an integral benefit of the **Etude Plus Low**, increasing safety and reducing the risk of harm for people who are prone to falling out of bed. The low level also makes it easier for patients to transfer in and out of bed.



Turnable Support Handle

The turnable support handle provides good support when moving into a standing position.

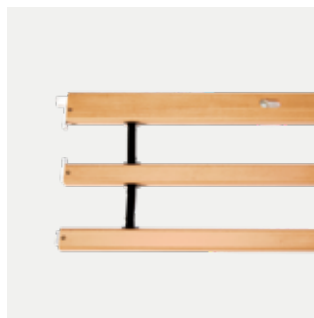

Britt V

Full-length side rails in beech. Compliant with IEC 60601-2-52.



Line/Line Extended

Full-length aluminium side rails. Compliant with IEC 60601-2-52.



Height Extender

Height of full-length side rails can be increased by 150 mm.



Lifting Pole

Light and easily adjustable (optional).



Transport Kit

For easy storage and enhanced portability.



Mattress Support Extension

For maximum customisation and personal comfort, choose between an extension of 100 or 200 mm.



Cover for wooden side rail

Padded cover for wooden side rails. Cover remains in place when side rail is lowered. Available in standard, padded and net.

Features and options

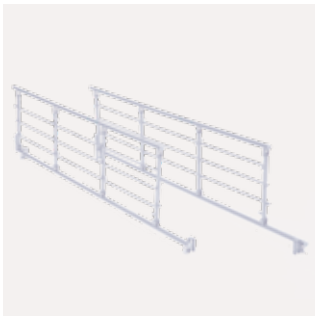

Invacare **Scala Basic 2**

Foldable steel side rail. Compliant with the new standard for beds IEC 60601-2-52.

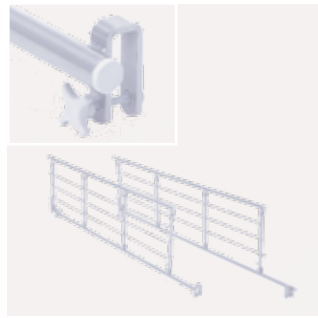

Invacare **Scala Basic Plus 2**

Foldable steel side rail with plastic inserts at the mounting brackets. Compliant with the new standard for beds IEC 60601-2-52.

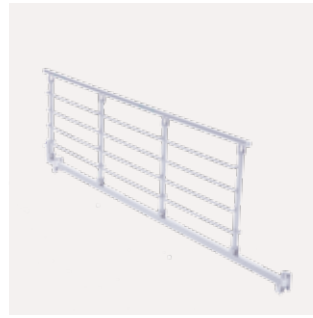

Invacare **Scala Medium 2**

Foldable steel side rail for deeper mattresses. Compliant with the new standard for beds IEC 60601-2-52.

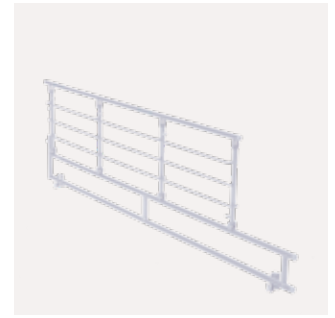











Invacare **Scala Decubi 2**

Foldable steel side rail for deep mattresses such as Dynamic systems. Compliant with the new standard for beds IEC 60601-2-52.

Technical data

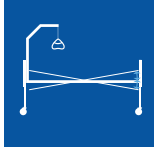
For more comprehensive pre-sales information about this product, including the product's user manual, please visit www.invacare.co.uk.

	Width outside Width inside	Length outside Length inside	Height adjustment	Mattress support dimensions	Backrest angle	Thigh angle	Legrest lift
Etude Plus Low	 1020 mm 900 mm	 2190 mm 2070 mm Mattress: 2000mm	 200 - 600mm / 270 - 670mm	 850 - 240 - 350 - 560 mm	 0 - 70°	 0 - 18°	 0 - 25°

	Tilt option ¹	Total weight	Max. user weight	Heaviest part of the product	
Etude Plus Low	 11° Tilt option**	 75.4kg	 SWL 200kg/ 31.5 stone Max user weight 165kg/ 26 stone	 24.6kg	Complies with IEC 60601-2-52. * A reduction in shear and friction forces may contribute to reduced risk of pressure ulcer formation. ** Please note that the tilt function is only suitable for users under medical supervision.

1. Please note that the tilt function is only practised for users under medical supervision.

NB
The bed must not be used by patients under 12 years of age, or by patients with body size equivalent to an average 12 year old or smaller.

Frame colour and wood work

Aluminium grey

Beech



Please note colours may vary slightly from those displayed above.

Warranty

5 years frame
5 years actuators
2 years hand control

The *Invacare Etude Plus Low* is part of the Safe Patient Handling range.



safepatienthandling

Invacare Limited
Pencoed Technology Park - Pencoed
Bridgend CF35 5AQ - United Kingdom
Tel: +44 1 656 776 222
Fax: +44 1656 776 220
E-mail: uk@invacare.com
Sales Order E-mail: ordersuk@invacare.com
www.invacare.co.uk

Invacare Ireland Ltd
Unit 5 - Seatown Business Campus
Seatown Road - SWORDS - County Dublin - Ireland
Tel. +353 1 8107084
Fax +353 1 8107085
Email: Ireland@invacare.com
www.invacare.ie

